

SAK 362-3/3

POWER LINE FILTER WITH IEC 320 C 14 PLUG & FUSE



In Conformation with
EMC Directive 2014/30/EU
Low Voltage Directive 2014/35/EU

RoHS
Compliant

SPECIFICATIONS

Rated Voltage :	250V, 50/60Hz
Rated current :	3A at room temp 40 C
Test Voltage :	2000V dc between Line to earth for 2 Secs.
Insulation Resistance :	>100 M Ohm between mains terminals shorted together & earth at 500 VDC.
Leakage Current :	2 * 0.2 mA max at Normal Condition.
Temperature Range :	0 to 85 C

CIRCUIT DIAGRAM

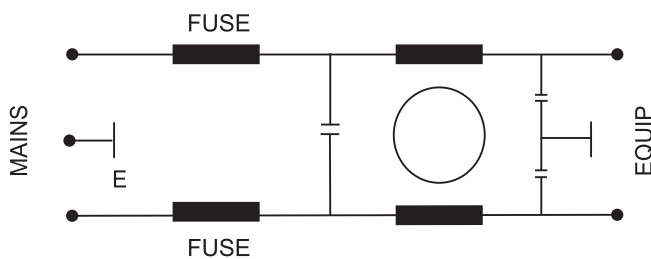

Common Mode Insertion Loss

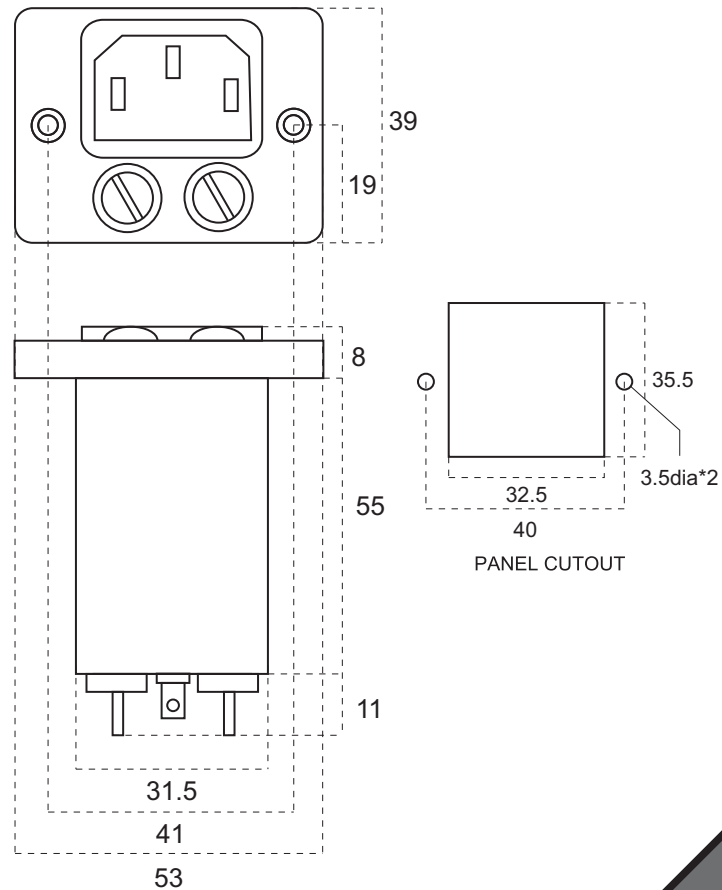
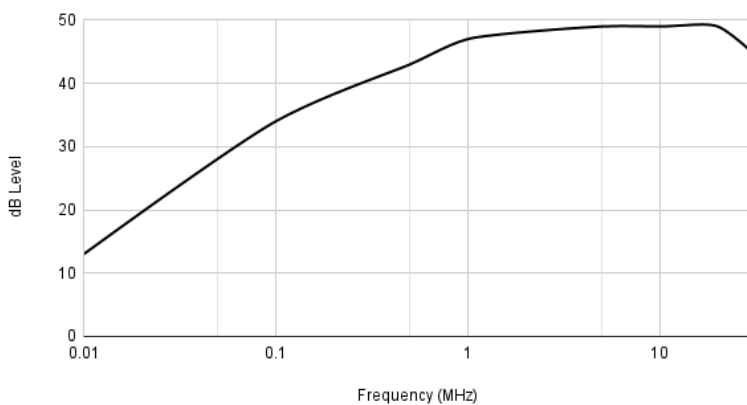

Material : MS, Plating : Nickel

DRG-REF: M1-0924

E-mail: sakura.rane@gmail.com

Visit Us: www.sakuraindia.com

Mobile: +91 98693 32286

E-mail: sakuraradhika@gmail.com

Whatsapp : +91 98204 26920

Contact
Us